



UMS102

Features

- Better additional short-term stability, up to $2.0E-14/1s$
- Ultra low phase noise $\leq -130dBc/Hz@1Hz$, $\leq -171dBc/Hz@1kHz$
- Low spurious $\leq -100dBc$

Applications

- Frequency standards and sources
- Measuring and calibration equipment
- Navigation

Technical Specifications

Input Sign specifications		
Frequency range	10MHz \pm 10Hz	
Wave form	Sine wave	
Power	10 \pm 2 dBm	
Harmonics	≤ -30 dBc	
Spurious	≤ -70 dBc	
Load	50 Ω \pm 5%	
Output Sign specifications		
Frequency range	20MHz \pm 20Hz	
Wave form	Sine wave	
Power	10 \pm 3 dBm	
Harmonics	≤ -40 dBc	
Spurious	≤ -80 dBc	≤ -100 dBc
Load	50 Ω \pm 5%	
Powe stability vs Temperature (-40°C to 70°C)	≤ 2.0 dB	
Additional short-term stability		
$\leq 2 \times 10^{-14}/1s$		
Phase Noise (dBc/Hz)	Option: S	Option: U
1 Hz	-125	-130
10 Hz	-140	-145
100 Hz	-155	-160
1 KHz	-166	-171
10 KHz	-166	-171
Input voltage range		
12 VDC \pm 5%		
Power consumption (at 25°C)	2W	
Vibration	MIL-STD-202G	
Size (L×W×H)	55×45×13mm ³	



Outline drawing and Electrical connections (mm)

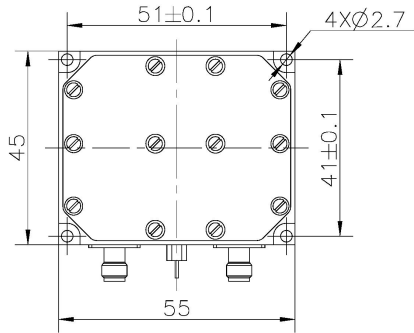
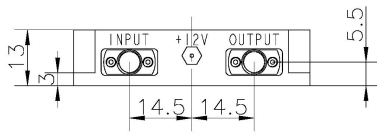

INPUT: 10MHz (SMA-F)
OUTPUT: 20MHz (SMA-F)
+12V: DC +12v

